

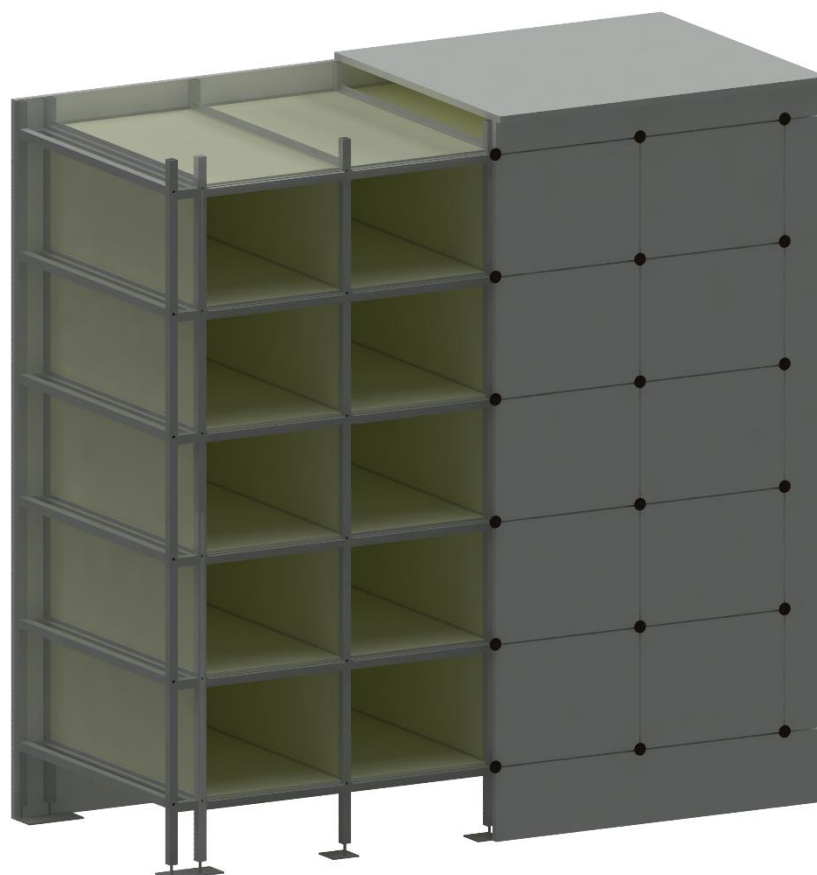

SCHEMA TECNICA

OSSARI PREFABBRICATI IN FIBROCEMENTO



PIANTA

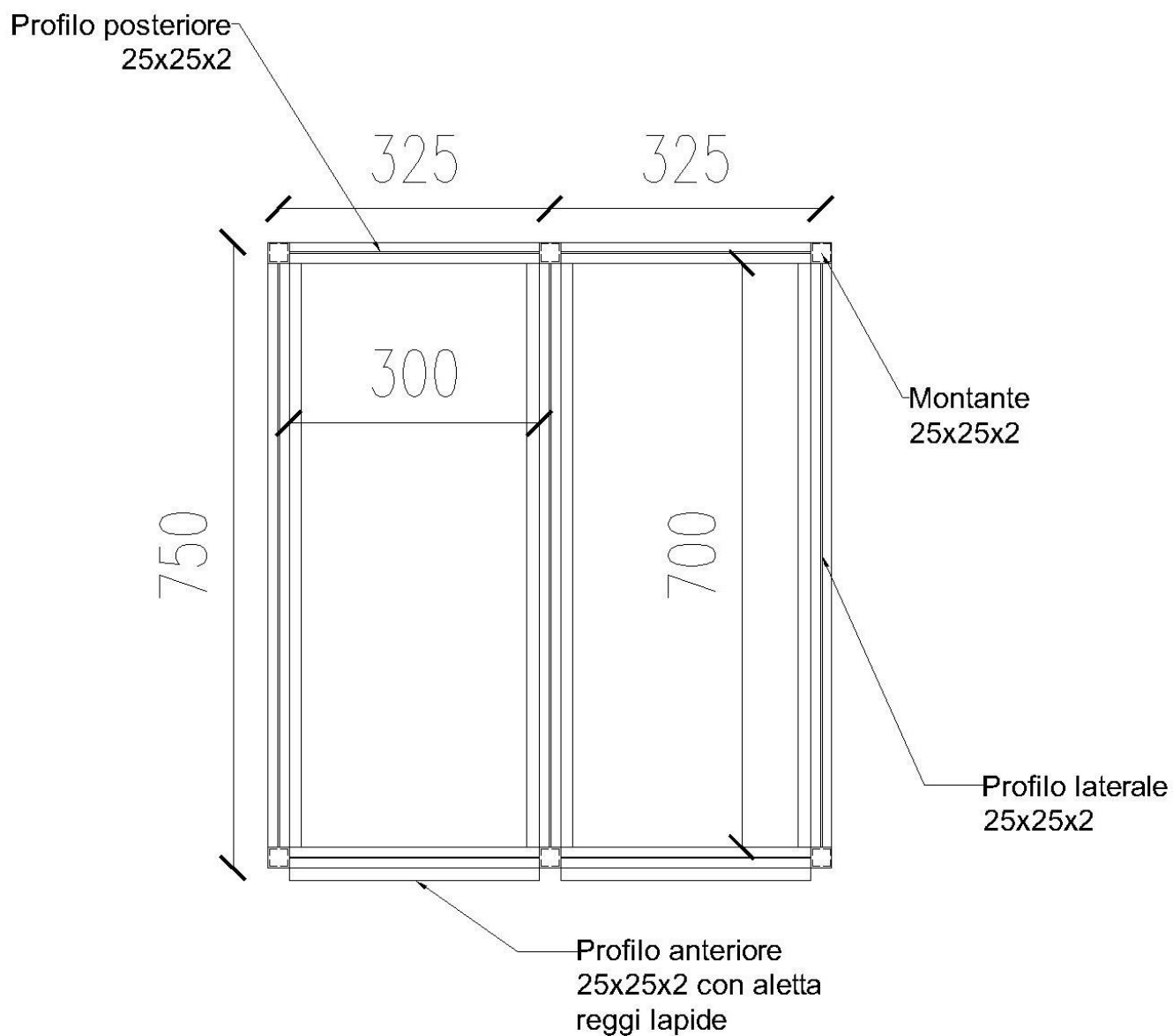

PROSPETTO FRONTALE

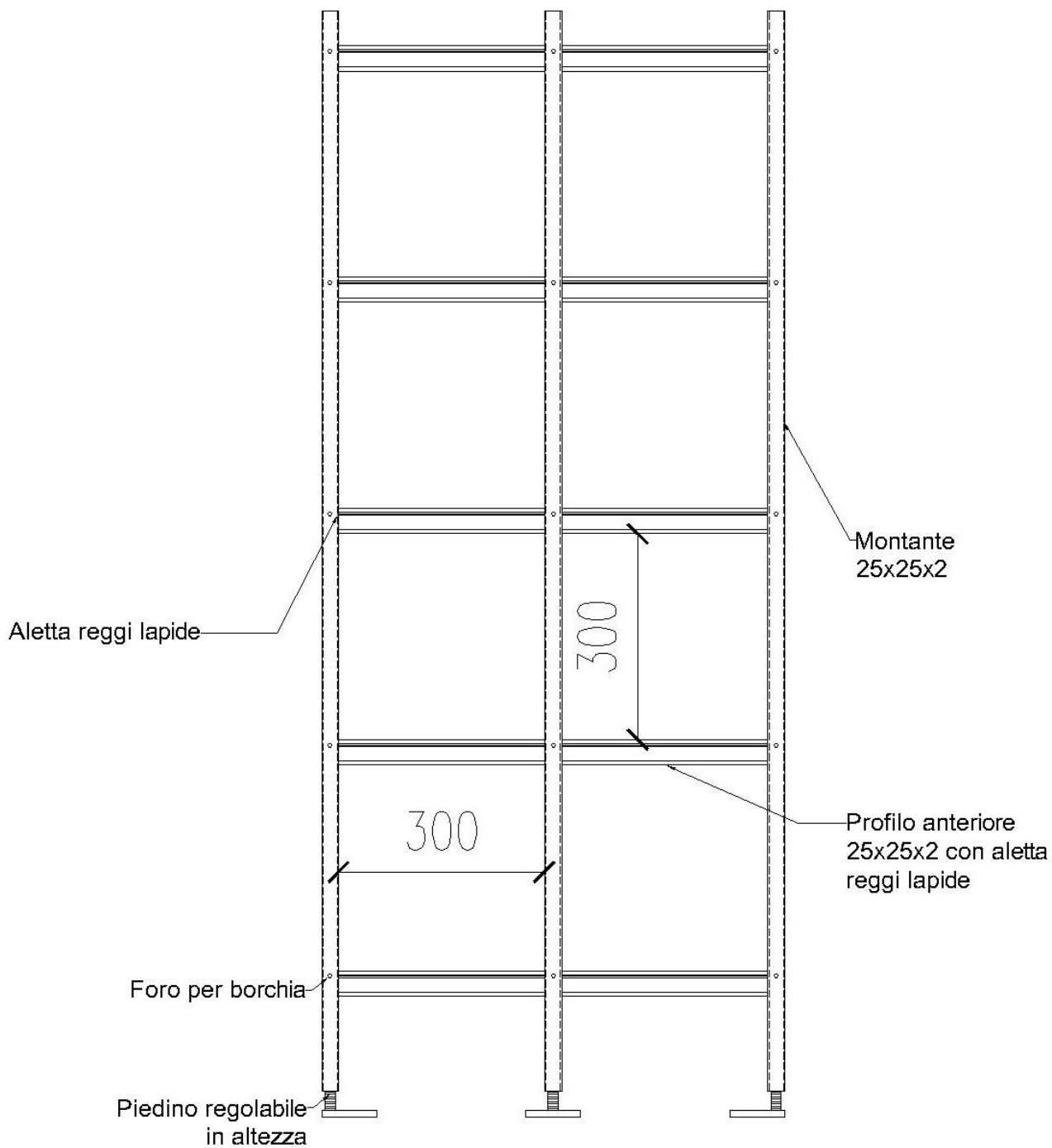

SEZIONE

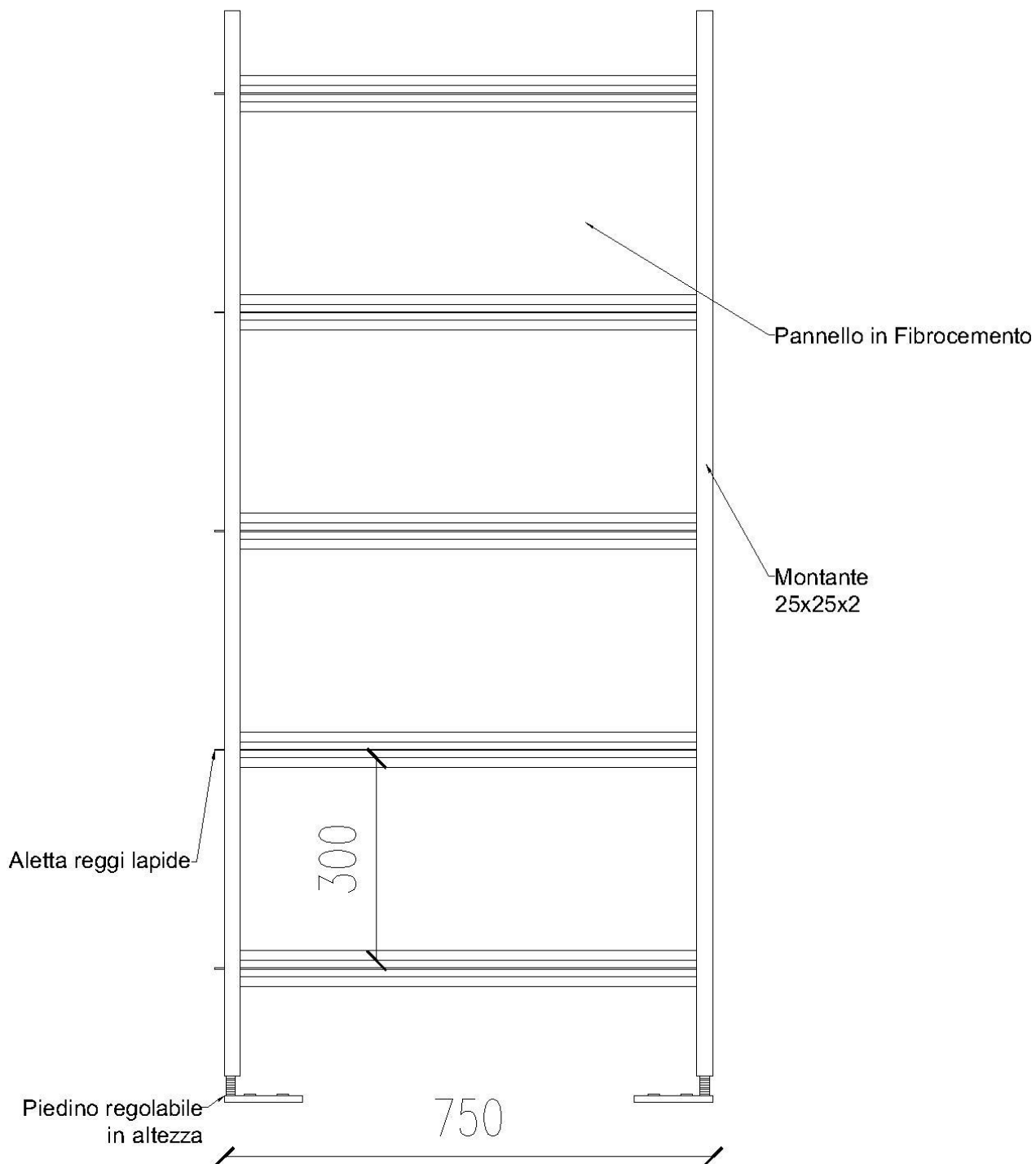

VISTA STRUTTURA 3D



Figura 1 - Copertura



Figura 2 - Borchia in bronzo

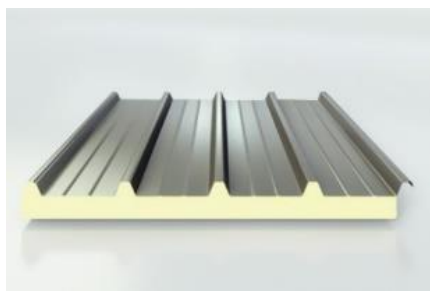
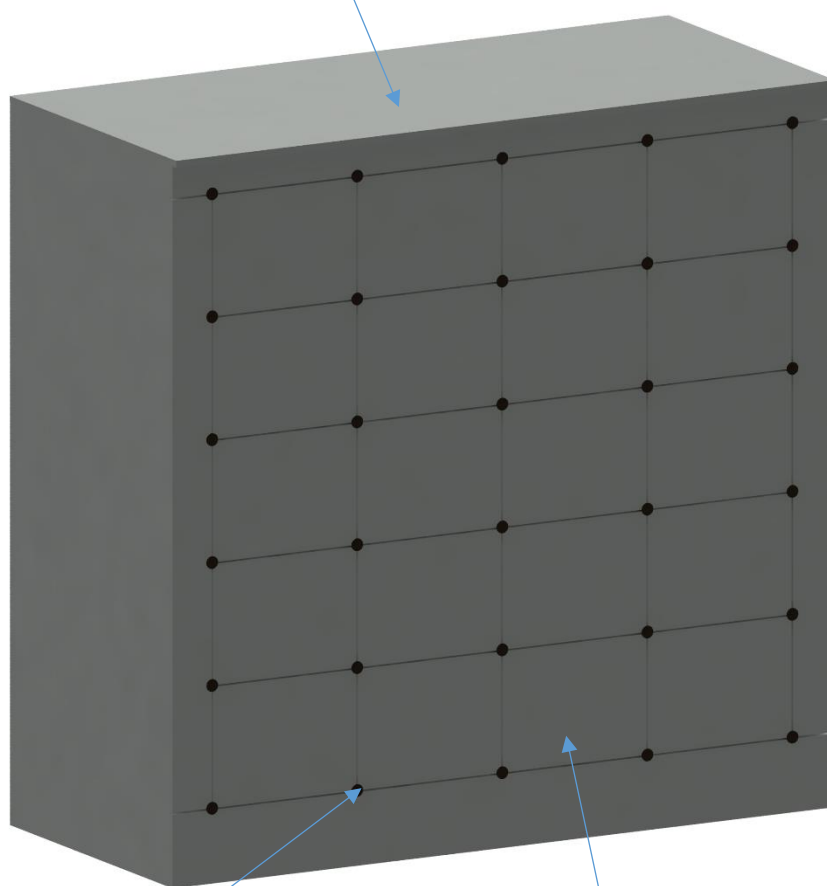
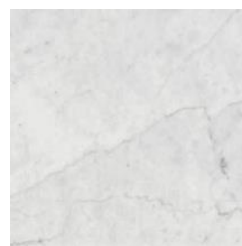

Figura 3 - Marmo